

# HILTI

## DD-REC 1

Bedienungsanleitung **de**

Operating instructions **en**

Mode d'emploi **fr**

操作說明書 **zh**

取扱説明書 **ja**

사용설명서 **ko**



1

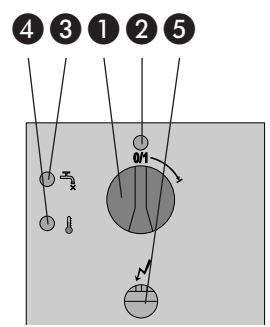
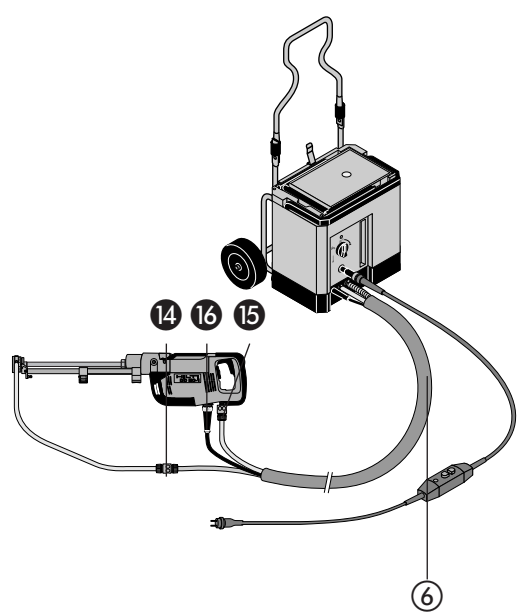
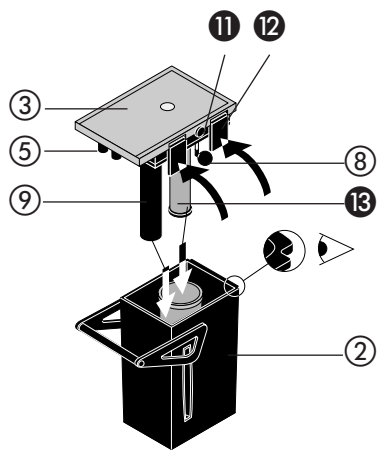
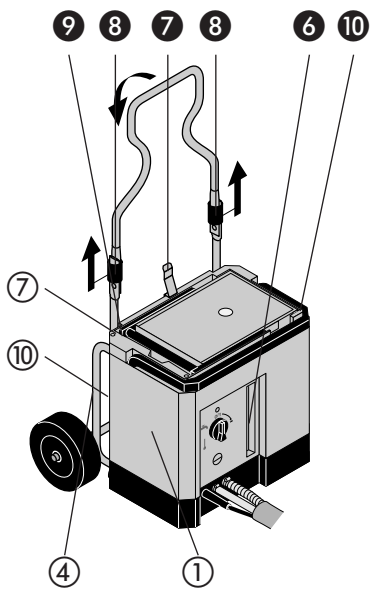

# DD-REC 1 water recycling system

**It is essential that the operating instructions are read before the unit is used for the first time.**

**Always keep these operating instructions together with the unit.**

**Ensure that the operating instructions are with the unit when it is given to other persons.**

## Operating controls **1**

- 1 ON / OFF switch
- 2 ON indicator lamp
- 3 Water warning lamp
- 4 Temperature warning lamp
- 5 Keyed plug connection for electric cable (supply cord socket)
- 6 Water level / slurry volume sight glass
- 7 Trolley release lever
- 8 Trolley handle lock
- 9 Container grip
- 10 Housing grip
- 11 Air release valve
- 12 Container cover latch
- 13 Main filter
- 14 Extraction hose coupling
- 15 Water supply hose coupling
- 16 Keyed plug connection for electric cable (Plug for drilling machine)

Contents	Page
General information	11
Description	11
Technical data	12
Accessories	13
Safety precautions	13
Before use	14
Operation	14
Care and maintenance	17
Manufacturer's warranty – tools	17
Disposal	18
Troubleshooting	19
Declaration of conformity (original)	20

## General information

 In these operating instructions, this symbol indicates points of particular importance to safety. The instructions at these points must always be observed in order to avoid a risk of serious injury.

 Caution: High voltage

**1** The numbers refer to the illustrations on the fold-out cover pages (front and rear cover).

**1** / **1** The numbers refer to the operating controls / component parts of the unit.

In these operating instructions, the electric appliance to which these operating instructions apply is referred to as “the unit”.

## Component parts **1**

- 1 Housing
- 2 Container
- 3 Cover
- 4 Wheel assembly / Trolley
- 5 Nipple
- 6 Hose set
- 7 Pocket for documents about the unit
- 8 Float
- 9 Sedimentation tube
- 10 Type plate

## Description

The DD-REC 1 is an electrically powered water recycling unit for use with the DD EC-1 diamond core drilling machine.

**Items supplied:** recycling unit, wheel assembly, operating instructions, cleaning pad

 **The following conditions must always be observed when the unit is in use:**

- The unit must be connected to an alternating current electric mains supply in compliance with the information given on the type plate.
- The unit may be used only with the supply cord for the DD EC-1 diamond drilling machine.
- The unit must not be operated in areas where there is a risk of explosion.

## Technical data

Nominal power input:	300 W
Nominal voltage: *	100 V 110 V 120 V 220 V 230 V 240 V
Mains frequency:	50–60 Hz
Weight of unit (without water):	25 kg
Water volume:	4–13 l
Max. number of holes per filling: **	Approx. 50
Dimensions (without wheels):	500×330×420 mm
Max. water pressure:	6 bar
Permissible operating temperature range:	+ 3 ... +50°C
Permissible storage or transport temperature range:	–15 ... +50°C (without water, remove the filter)

**\* The unit is offered in different versions for various mains voltages. Please refer to the information on the type plate for the nominal voltage and nominal current input of your unit.**

**\*\* Measured at 20 mm dia. and 125 mm drilling depth; depends on base material, drilling direction and type of hole drilled (through hole, blind hole)**

### Noise information (in accordance with EN 61029)

Typical A-weighted emission sound pressure level ( $L_{pA}$ ): 76 dB (A)

## Main features of the unit

- Class I electrical protection
- Extraction of drilling slurry
- Water is retrieved from the drilling slurry (recycling)
- Supplies water and power for the DD EC-1 diamond core drilling machine
- Integrated supply and return hose set for connecting the DD EC-1 diamond core drilling machine
- Automatic filter flushing
- Filter can be regenerated
- Stand-by operation
- Warning indicators for:
  - inadequate water flow
  - overheating
- Self-check of the electronics carried out each time the unit is switched on
- Removable container for water and drilling slurry
- Removable wheel assembly, also provides suitable surface for laying down the toolbox for the diamond core drilling machine

Right of technical changes reserved

## Intended uses

### The unit is intended for the following uses

- Extraction of drilling slurry and supplying water and power to the DD EC-1 diamond core drilling machine for drilling in mineral materials (reinforced concrete, masonry and natural stone)
- The unit may be operated only when standing on a horizontal surface and in an upright position.
- Clean water should be used as the cooling and flushing medium.



The water recycled by the unit is almost entirely free of particles but may contain substances released by the material in which the hole is drilled. Under no circumstances should this water be considered suitable for use as drinking water.

**Do not, under any circumstances, use this product in any way other than as described in these operating instructions.**

### Use protective equipment.



Read the operating instructions



Eye protection must be worn.



Protective gloves must be worn.

## Safety precautions

When using the unit, the following fundamental safety precautions must always be observed in order to avoid the risk of injury, electric shock and fire hazards. Please read and observe the instructions before using the unit.

### Wear suitable working clothing.

Wear shoes with non-slip soles.

### Make the working area safe.

Objects which could cause injury should be removed from the working area. Ensure that the area is well lit. When working, keep other persons, children in particular, away from the unit.

### Take the influences of the surrounding area into account.

Do not expose the unit to rain or snow and do not operate it in damp or wet environments or in the vicinity of flammable liquids or gases.



### Check the unit each time before use.

First check the condition of the supply cord with PRCD/GFCI residual current device (supplied with the DD EC-1 diamond core drilling machine) and then check

## Accessories

- Replacement main filter, item number 377255 (wearing part)

Drilling slurry and recycled drilling water may irritate the skin and eyes. Rinse with water immediately after skin contact. If allowed to come into contact with the eyes, rinse with plenty of water and consult a doctor. The water, container and hoses may become very hot after long periods of use and present a risk of burning or scalding.

the condition of the unit, including the supply cord and the plug (an integral part of the hose set, except for the GB version). Do not operate the unit if any parts of it are found to be damaged, if the unit is not complete or when the operating controls cannot be operated faultlessly.

### Use the correct accessories.

Use only the recommended original Hilti accessories.

### Use the unit only for the purposes for which it is intended.





### Apply a safe working method.

Always ensure that you have a safe stance and that the unit is standing securely. On scaffolding or similar platforms, the unit should be used without the wheel assembly. Never stand on the unit. The wheel assembly, housing and container grips should never be used as attachment points for lifting by a crane hook or similar means. If the unit is to be transported by crane, the applicable safety regulations must be observed.

Ensure that the unit, supply cord and hose set are positioned where they are free of obstructions. When working, always guide the hose set away from the diamond

core drilling machine to the rear. Never carry the unit by the supply cord or hose set and never pull on these parts. Never drive over the hoses or supply cord. Don't unplug the unit by pulling on the supply cord. Don't expose the hoses or supply cord to heat, oil or sharp edges. If the supply cord becomes damaged while working, don't touch it – unplug the mains plug immediately and have the unit or supply cord repaired at a Hilti service centre. Never expose the plug connections for the unit to water. If a plug interface has become wet, always disconnect the supply cord plug from the mains socket before touching it and wiping it dry. Check that the pins of the plug and the supply cord are clean and dry before they are connected. Unplug the supply cord from the mains socket before cleaning.



### Avoid unintentional starting.



  Always switch off the unit and unplug the supply cord from the mains socket before removing the container, when the unit is not in use (e.g. during pauses between work), before cleaning and before carrying out any maintenance.

### Keep the unit in good condition.

Follow the instructions on care and maintenance. Repairs to the unit may be carried out only by an authorised electrical specialist using original Hilti spare parts. Failure to observe this point may result in damage to the unit or present a risk of accident. Accordingly, if necessary, have the unit repaired at a Hilti service centre or authorised Hilti repair workshop. In accordance with national safety regulations, the safety function of the earth / ground conductor must be checked at regular intervals.

## Before use

  It is essential that the safety precautions printed in these operating instructions are read and observed. Also read and observe the instructions and safety precautions listed in the operating instructions for the DD EC-1 diamond core drilling machine.

  The DD-REC1 water recycling system should be used exclusively with the DD EC-1 diamond core drilling machine and the corresponding supply cord with built-in PRCD residual current device (supplied with the DD EC-1 diamond core drilling machine). In Great Britain, the 110 V units must be connected to an isolating transformer.

 The mains voltage must comply with the information on the type plate.

 If extension cables are used: only extension cables of a type approved for the intended use and of adequate cross section may be used. Failure to observe this point may result in reduced performance and could cause the cable to overheat. Damaged extension cables must be replaced.

The recommended cable cross sections and maximum lengths are as follows:





Mains voltage	Conductor cross section			
	1.5 mm <sup>2</sup>	2.0 mm <sup>2</sup>	2.5 mm <sup>2</sup>	3.5 mm <sup>2</sup>
100 V	20 m			40 m
110 V	20 m	40 m		
220–230 V	50 m	80 m		

## Operation

### Connecting the hose set to the drilling machine

- Connect the keyed electric supply cord plug from the hose set to the socket on the underside of the drilling machine. To do this, bring the marks on the plug and the socket into alignment and then push the plug into the socket on the machine as far as it will go. While maintaining slight pressure on the plug, rotate it in a clockwise direction until it is heard to engage **2**.
- Connect the thin end of the hose from the hose set to the drilling machine and the thick end of the hose to the water collector hose connector. The couplings must be heard to engage when connected.

### Removing and opening the container

-  Never remove the container while the unit is switched on. Switch the unit off by turning the on / off switch in a clockwise direction and disconnect the mains plug **3**.
-    Wear protective gloves and protective goggles. The contents of the container may irritate the skin and eyes. The container and its contents may be hot after long periods of use. Observe the safety precautions. When handling the container, take care to avoid pinching your fingers at the edges of the housing, grips and latches.
- Lift the container grip approx. 45° and hold it in this position until pressure compensation is heard to be complete (approx. 2 seconds). Failure to observe this point may cause a large quantity of the container contents to escape at the nipples.
- Lift the container grip to the vertical position and pull the container upwards out of the housing **4**.
- Always transport the container in an upright position or place it on a horizontal surface.
- Ensure that it stands securely.
- Open the four container cover latches **5**.
- Lift the cover off the container, taking care to ensure that the float ball doesn't get stuck. Lay the cover down carefully.

### Filling, closing and inserting the container

- Fill the inner container up to the top edge with clean water **6**. Fill the outer container to the desired level between the min. and max. marks.
- Check the inner and outer cover seals for damage.

Carefully remove dirt from the surfaces of the seals. Ensure that the main filter is seated securely. Check that the air release valve moves easily **11**.

- Place the cover on the container. Take care to ensure that it is positioned correctly, the right way round (the lugs at both corners of the cover located in the corresponding recesses in the container **5** and **7**). The nipple block is then positioned at the same side as the container water level sight glass. When the cover is placed in position, take care to ensure that the container latches and the float hose are not pinched between the container and the cover. Care must also be taken to ensure that the suction hose hangs down into the water and that the float ball is free to float **7**.
- Close the container latches. To do this, first engage the latches on the container and then press the latches towards the cover. The container latches must be heard to engage. It may be necessary to press the cover down slightly.
-  Always use all four container latches. Never use the unit when the container latches are damaged.
- Lift the container by its handle and insert it carefully, the right way round, in the housing. When doing so, the guide ribs on the container must be carefully inserted into the corresponding openings in the housing. Do not allow the container to drop into the housing **8**.
- Fold the container handle down to the nipples side until it is flush with the top surface of the housing. It may be necessary to press the cover down slightly.
- Never attempt to fill the unit through the hoses. It must always be filled as described above.

### Operation

- Check the sight glass **6** to ensure that sufficient water is in the container.
- Connect the unit to the mains supply. Use the supply cord with the built-in PRCD residual current device (supplied with the diamond core drilling machine). Insert the keyed plug in the socket as described above. Insert the mains plug in the mains socket.
- Switch on the residual current device by pressing the green button. The self-test function of the unit is then activated. All warning lamps light briefly and an acoustic signal is emitted.
-  Test the residual current device for correct functionality. To do this, press the black test button. The ON indicator on the unit must extinguish. After testing, switch on again by pressing the green button.
- Switch on the unit by turning the ON / OFF switch in a clockwise direction as far as it will go. It then takes about 20 seconds for the internal parts of the system to fill with water. During this time, the water supply system is not fully operational. Subsequently, the green ON indicator lights to show that the unit is ready for use.
- Start the water supply system by operating the switch on the DD EC-1 diamond core drilling machine. Adjust the water volume as desired by turning the regulator on the diamond core drilling machine and begin drilling

(please refer to the operating instructions for the DD EC-1 diamond core drilling machine).

- Automatic filter flushing begins (takes about 15 to 20 seconds) when the switch on the DD EC-1 diamond core drilling machine is not operated for several seconds. The unit supplies no water during this time.
- After completion of the filter flushing procedure, the unit is again ready for use and the next drilling operation can be started (ready mode).
- Stand-by mode: If the switch on the diamond core drilling machine is not pressed for a period of more than 15 minutes, the unit automatically releases pressure and enters stand-by mode. In this case, before beginning the next drilling operation, the switch on the diamond core drilling machine must be pressed briefly in order to re-pressurise the unit. After a few seconds, the unit is again ready to supply water.

### Warning indicators

- Acoustic warning signal (without warning lamp): This indicates inadequate water flow which could be caused by incorrect adjustment of the regulator valve in manual operation or other malfunctions (please refer to the “Troubleshooting” section).
- Water warning lamp **3** (simultaneous acoustic warning signal): This indicates inadequate water pressure. Could be caused by the container being empty, blocked filter or other malfunctions (see “Troubleshooting” section).
- Temperature warning lamp **4** (simultaneous acoustic warning signal): This indicates excessively high water temperature. Stop using the system immediately (see “Troubleshooting” section).
- Water level / slurry volume sight glass **6**: This indicates the drilling slurry level and the remaining quantity of water in the container. It provides useful fault-finding information in case of malfunctions and makes it possible to estimate the number of holes which can be drilled before emptying and refilling. Due to widely varying conditions (diameter, depth, etc.), it is not possible to give an exact indication of the number of holes which can be drilled.

### Cleaning the container

The container should be emptied and cleaned in the following cases (it is generally recommended that the main filter is cleaned at the same time):

- Malfunctions caused by the slurry level being too high or the water level being too low (see “Troubleshooting” section).
- Unit is switched off permanently (e.g. at the end of the working day).
- Remove the container from the housing and open it as described above. Observe the safety precautions.
- Dispose of the container contents in accordance with the information in the “Disposal” section and under observance of local regulations.
- Rinse out the remaining slurry and, if necessary,

remove dried-on remains. Wipe the inside of the sight glass with a soft cloth. Clean the surfaces of the seals on the container carefully **9**. Rinse out the container under running water. Do not use a high-pressure cleaning system.

- Clean the main filter (see below).
- Fill the container as described above, close it and then insert it in the housing.

### Regenerating the main filter

- Regeneration of the main filter is recommended in the following situations:
  - When malfunctions caused by blockage of the main filter are experienced
  - Each time the container is refilled
- Remove the container from the housing as described above and open it. Observe the safety precautions.
- Unscrew the main filter from the cover. When doing so, do not hold the filter by the ceramic body. Instead, grip it only by the grip section on the underside of the main filter (reduces risk of breakage) **10**.
- Clean the main filter under running water, using the sandpaper supplied, by rubbing it in a longitudinal direction on all sides until the light colour of the ceramic body reappears **11**. During this process, the outermost surface of the ceramic body is rubbed off. This regeneration procedure can be repeated up to about 20 times until the minimum wall thickness of the ceramic body is reached.
- Check the wall thickness of the ceramic body. The main filter must be replaced as soon as the diameter of the ceramic body reaches a minimum of 42 mm. Failure to observe this point could result in cracking or breakage of the ceramic body **12**.
- Check the main filter. Replace it immediately if cracked or broken. A defective main filter may cause damage to the recycling unit and to the diamond core drilling machine.
- Screw the main filter into the cover until resistance is clearly felt. Then continue to turn the filter a further 45° (maximum). Screwing the filter in beyond this point does not improve the efficiency of the filter seal and may result in permanent damage to the filter or cover parts.
- Fill the container as described above, close it and then insert it in the housing.

### Drying the main filter

- In rare cases, regeneration of the main filter may not be sufficient to clear a blockage. Should this be experienced, allow the main filter to dry for at least 24 hours, standing upright with the thread at the top, in a warm, dry place before it is reused.

### Replacement main filter

- The main filter is a wearing part with a limited life expectancy. The housing has provision for storing a spare main filter (not supplied). A spare filter is recommended. The container must be removed on order to access the storage location and insert a spare filter.

Insert the grip section of the spare main filter in the holder in the base of the housing at an angle and then bring the filter into a vertical position until it engages with the plastic tab. To remove the spare main filter, lift the plastic tab slightly and pull the filter out of the holder to the side.

### Switching off after use

- Before each long break between periods of use (e.g. after finishing work for the day). The recycling unit must be switched off as follows:
  1. Disconnect the mains plug.
  2. Release the hose connectors to the diamond core drilling machine. Connect the extraction hose and water supply hose connectors together.
  3. Release the keyed plug from the diamond core drilling machine. To do this, pull on the ring and turn the plug in a counterclockwise direction, as far as it will go, and then pull it out.
- Proceed as follows in order to avoid malfunctions caused by dirt deposits:
  1. Clean the container tank and main filter.
  2. Refill with fresh water.
  3. Plug the supply cord into the mains socket.
  4. Switch on the PRCD by pressing the green button.
  5. Switch on the unit by turning the ON/OFF switch in a clockwise direction, as far as it will go.
  6. Run the recycling unit for 10 minutes. Switch the recycling unit on/off at the main switch four times during these 10 minutes. This will flush out the internal tubing and valves of the recycling unit.
  7. Disconnect the mains plug.
- Clean the container and regenerate the main filter.

### Transport without wheel assembly

- A handle **10**, which can be folded out easily, is provided for transporting the unit by hand. Grip sections are provided at the sides for lifting the unit with both hands. Take care to avoid pinching your fingers at the grips.
-  A suitable means (net or straps) must be used when the unit is lifted by a crane. The wheel assembly, housing or container grip must never be used as a lifting point for a crane hook or other similar lifting tackle. When transporting the unit by crane, the applicable safety regulations must be observed **13**.

### Transport with wheel assembly

- Attaching the wheel assembly: Hold the unit against the guide tubes on the wheel assembly and allow it to slide down until the catch engages automatically. Take care to ensure that the feet of the unit are located in the corresponding sockets in the wheel assembly **14**.
- Wind the hose set around the wheel assembly handle for transport. If desired, the toolbox for the DD EC-1 diamond core drilling machine can be placed on the unit first.
- Detaching the wheel assembly: Push the lever to dis-



engage the catch and, at the same time, lift the unit away from the wheel assembly.

-  When using the wheel assembly, care must be taken to ensure that the wheels and the unit are standing securely. For safety reasons, the wheel assembly must not be used when working from scaffolding or similar platforms.



## Manufacturer's warranty – tools

Please contact your local Hilti representative if you have questions about the warranty conditions.

## Care and maintenance

### Care

The housing, container and cover are made of impact-resistant plastic. The protective sleeve of the cable and the hoses are made of an elastomer material. The outer sheath of the hose set consists of a hard-wearing woven synthetic material.

  Clean the parts of the unit regularly with a damp cloth. Do not use spray equipment, a steam cleaning system or running water for cleaning. This may negatively affect the electrical safety of the unit. Always keep the grip sections of the unit free of oil and grease. Do not use cleaning agents which contain silicone. Do not allow foreign objects to enter the interior of the unit.

**Regenerate the main filter and clean the container at regular intervals, particularly before each long pause between periods of use (e.g. at the end of the working day). Check the entire diamond drilling system for leakage before each period of operation. Check and clean the seals at regular intervals. Never leave drilling slurry or water in the container for long periods.**

### Maintenance

 Check all functional components and operating controls of the unit for damage and correct operation at regular intervals. Do not operate the unit if parts of it are damaged or when the operating controls do not operate faultlessly. The unit should be repaired at a Hilti service centre if necessary.

- See: – Regenerating the filter  
– Switching off after use.

## Disposal



Return waste material for recycling

Most of the materials from which Hilti electric tools are manufactured can be recycled. The materials must be correctly separated before they can be recycled. In many countries, Hilti has already made arrangements for taking back your old electric tools for recycling. Please ask your Hilti customer service department or Hilti representative for further information.



Only for EU countries

Disposal of electric tools together with household waste is not permissible!

In observance of European Directive on waste electrical and electronic equipment and its implementation in accordance with national law, electric tools that have reached the end of their life must be collected separately and returned to an environmentally compatible recycling facility.

### Handling drilling slurry

Drilling in mineral materials (e.g. concrete) with the DD EC-1 diamond core drilling machine produces drilling slurry. As with fresh cement mortar, this slurry may cause irritation if allowed to come into contact with the skin or eyes. Wear protective clothing, protective gloves and goggles.

With regard to environmental aspects, allowing this slurry to flow directly into rivers, lakes or the sewerage system without suitable pre-treatment is problematical.

## Disposal procedure

**In addition to the following recommended pre-treatment procedures, the applicable national regulations must be observed when disposing of drilling slurry.**

**Ask the local authorities concerned for further information.**

### Recommended pre-treatment

- Water from the drilling slurry must be neutralised (e.g. by adding a large quantity of water or other neutralisation agent) before it is allowed to flow into the sewerage system.
- Solid material from the drilling slurry should be deposited at a construction waste disposal site.

## Troubleshooting

<b>Fault</b>	<b>Possible cause</b>	<b>Solution</b>
Unit doesn't start	Fault in mains supply	Plug in another electric appliance and check whether it works.
	Supply cord or plug defective	The cord should be checked and replaced if necessary by an electrical specialist.
	Unit defective	The unit should be repaired at a Hilti service centre.
Acoustic warning signal (without warning lamp)	Core bit or diamond core drilling machine blocked	Check for free flow and eliminate blockage.
	Regulating valve on diamond core drilling machine set too low in manual operation.	Open the regulating valve on the diamond core drilling machine.
	Water supply hose not connected to the diamond core drilling machine.	Connect the water supply hose to the diamond core drilling machine.
Water warning lamp lights; acoustic warning signal	Too little water or too much slurry in the container	Clean the container and refill it.
	Inner container not completely filled with water	Fill the inner container completely with water.
	Main filter blocked	Regenerate the main filter.
	Regulating valve opened in manual operation when the diamond core drilling machine is switched off	Close the regulating valve on the diamond core drilling machine.
	Seals defective	Check the seals on the cover and in the nipples for damage and have them replaced at a Hilti service centre if necessary.
	Container not inserted correctly in the unit	Check the position of the container in the housing; close the container handle carefully.
	Air release valve sticking	Check the air release valve to ensure free movement; have it repaired at a Hilti service centre if necessary.
	Pressure pump defective	Have it repaired at a Hilti service centre.
Temperature warning lamp lights; acoustic warning signal	Water temperature too high	Allow the container to cool or clean it and then refill it. Caution: Risk of burning or scalding!
Suction performance inadequate (leakage at water collector on the diamond core drilling machine)	Coarse filter in the water collector of the diamond drilling machine blocked	Remove coarse particles.
	Suction pump defective	Have it repaired at a Hilti service centre.
	The seals of the water tank don't seal off completely	Check if the surface and seals of the cover from the water tank are clean.

# EC declaration of conformity (original)

Description:	Water recycling unit
Designation:	DD-REC 1
Year of design:	2000

We declare, under our sole responsibility, that this product complies with the following directives and standards: until 19th April 2016: 2004/108/EC, from 20th April 2016: 2014/30/EU, 2006/42/EC, 2011/65/EU, EN 60335-1, EN 12100.

**Hilti Corporation, Feldkircherstrasse 100,  
FL-9494 Schaan**



**Paolo Luccini**  
Head of BA Quality and Process Management  
BA Electric Tools & Accessories  
06/2015



**Johannes W. Huber**  
Senior Vice President  
Business Unit Diamond  
06/2015

**Technical documentation filed at:**  
Hilti Entwicklungsgesellschaft mbH  
Zulassung Elektrowerkzeuge  
Hiltistrasse 6  
86916 Kaufering  
Deutschland



Hilti Corporation

LI-9494 Schaan

Tel.: +423 / 234 21 11

Fax: +423 / 234 29 65

[www.hilti.com](http://www.hilti.com)

Hilti = registered trademark of Hilti Corp., Schaan  
Pos. 4 | 20150922



337353