





Hilti HIT-RE 500 mortar with HIT-V / HAS rod

Injection mortar system	Benefits
 <p>Hilti HIT-RE 500 330 ml foil pack (also available as 500 ml and 1400 ml foil pack)</p>	<ul style="list-style-type: none"> - SAFEset technology: drilling and borehole cleaning in one step with Hilti hollow drill bit - suitable for non-cracked concrete C 20/25 to C 50/60 - high loading capacity - suitable for dry and water saturated concrete - under water application - large diameter applications - high corrosion resistant - long working time at elevated temperatures - odourless epoxy - embedment depth range: from 40 ... 160 mm for M8 to 120 ... 600 mm for M30
 <p>Statik mixer</p>	
 <p>HAS rod</p>	
 <p>HAS-E rod</p>	
 <p>HIT-V rod</p>	



Concrete

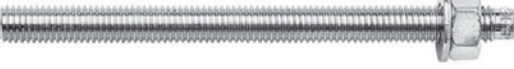

Small edge distance and spacing

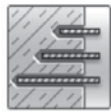

Variable embedment depth



Fire resistance



Corrosion resistance



High corrosion resistance



Diamond drilled holes

SAFEset

Hilti SAFEset technology with hollow drill bit



European Technical Approval



CE conformity



PROFIS Anchor design software

Approvals / certificates

Description	Authority / Laboratory	No. / date of issue
European technical approval a)	DIBt, Berlin	ETA-04/0027 / 2013-06-26
Fire test report	IBMB, Braunschweig	UB 3565 / 4595 / 2006-10-29 UB 3588 / 4825 / 2005-11-15
Assessment report (fire)	warringtonfire	WF 327804/B / 2013-07-10

a) All data given in this section according ETA-04/0027, issue 2013-06-26.

Basic loading data (for a single anchor)

All data in this section applies to

For details see Simplified design method

- Correct setting (See setting instruction)
- No edge distance and spacing influence
- *Steel* failure
- Base material thickness, as specified in the table
- One typical embedment depth, as specified in the table
- One anchor material, as specified in the tables
- Concrete C 20/25, $f_{ck,cube} = 25 \text{ N/mm}^2$
- Temperature range I
(min. base material temperature -40°C , max. long term/short term base material temperature: $+24^\circ\text{C}/40^\circ\text{C}$)
- Installation temperature range $+5^\circ\text{C}$ to $+40^\circ\text{C}$

Embedment depth ^{a)} and base material thickness for the basic loading data.

Mean ultimate resistance, characteristic resistance, design resistance, recommended loads.

Anchor size	M8	M10	M12	M16	M20	M24	M27	M30	M33	M36	M39
Typical embedment depth [mm]	80	90	110	125	170	210	240	270	300	330	360
Base material thickness [mm]	110	120	140	165	220	270	300	340	380	410	450

a) The allowed range of embedment depth is shown in the setting details. The corresponding load values can be calculated according to the simplified design method.

For hammer drilled holes and hollow drill bit:

Mean ultimate resistance: concrete C 20/25 – $f_{ck,cube} = 25 \text{ N/mm}^2$, anchor HIT-V 5.8

			ETA-04/0027, issue 2013-06-26 for hammer drilling and hollow drill bit							Additional Hilti technical data			
Anchor size			M8	M10	M12	M16	M20	M24	M27	M30	M33	M36	M39
Tensile $N_{Ru,m}$	HIT-V 5.8	[kN]	18,9	30,5	44,1	83,0	129,2	185,9	241,5	295,1	364,4	428,9	459,9
Shear $V_{Ru,m}$	HIT-V 5.8	[kN]	9,5	15,8	22,1	41,0	64,1	92,4	120,8	147,0	182,2	214,5	256,2

Characteristic resistance: concrete C 20/25 – $f_{ck,cube} = 25 \text{ N/mm}^2$, anchor HIT-V 5.8

			ETA-04/0027, issue 2013-06-26 for hammer drilling and hollow drill bit							Additional Hilti technical data			
Anchor size			M8	M10	M12	M16	M20	M24	M27	M30	M33	M36	M39
Tensile N_{Rk}	HIT-V 5.8	[kN]	18,0	29,0	42,0	70,6	111,9	153,7	187,8	224,0	262,4	302,7	344,9
Shear V_{Rk}	HIT-V 5.8	[kN]	9,0	15,0	21,0	39,0	61,0	88,0	115,0	140,0	173,5	204,3	244,0

Design resistance: concrete C 20/25 – $f_{ck,cube} = 25 \text{ N/mm}^2$, anchor HIT-V 5.8

			ETA-04/0027, issue 2013-06-26 for hammer drilling and hollow drill bit							Additional Hilti technical data			
Anchor size			M8	M10	M12	M16	M20	M24	M27	M30	M33	M36	M39
Tensile N_{Rd}	HIT-V 5.8	[kN]	12,0	19,3	27,7	33,6	53,3	73,2	89,4	106,7	125,0	144,2	164,3
Shear V_{Rd}	HIT-V 5.8	[kN]	7,2	12,0	16,8	31,2	48,8	70,4	92,0	112,0	138,8	163,4	195,2

Recommended loads ^{a)}: concrete C 20/25 – $f_{ck,cube} = 25 \text{ N/mm}^2$, anchor HIT-V 5.8

			ETA-04/0027, issue 2013-06-26 for hammer drilling and hollow drill bit							Additional Hilti technical data			
Anchor size			M8	M10	M12	M16	M20	M24	M27	M30	M33	M36	M39
Tensile N_{rec}	HIT-V 5.8	[kN]	8,6	13,8	19,8	24,0	38,1	52,3	63,9	76,2	89,3	103,0	117,3
Shear V_{rec}	HIT-V 5.8	[kN]	5,1	8,6	12,0	22,3	34,9	50,3	65,7	80,0	99,1	116,7	139,4

a) With overall partial safety factor for action $\gamma = 1,4$. The partial safety factors for action depend on the type of loading and shall be taken from national regulations.

For diamond drilling:
Mean ultimate resistance: concrete C 20/25 – $f_{ck,cube} = 25 \text{ N/mm}^2$, anchor HIT-V 5.8

		ETA-04/0027, issue 2013-06-26 for diamond drilling							
Anchor size		M8	M10	M12	M16	M20	M24	M27	M30
Tensile $N_{R_u,m}$	HIT-V 5.8 [kN]	18,9	30,5	44,1	83,0	129,2	185,9	241,5	287,2
Shear $V_{R_u,m}$	HIT-V 5.8 [kN]	9,5	15,8	22,1	41,0	64,1	92,4	120,8	147,0

Characteristic resistance: concrete C 20/25 – $f_{ck,cube} = 25 \text{ N/mm}^2$, anchor HIT-V 5.8

		ETA-04/0027, issue 2013-06-26 for diamond drilling							
Anchor size		M8	M10	M12	M16	M20	M24	M27	M30
Tensile N_{R_k}	HIT-V 5.8 [kN]	18,0	29,0	42,0	70,6	111,9	153,7	183,2	216,3
Shear V_{R_k}	HIT-V 5.8 [kN]	9,0	15,0	21,0	39,0	61,0	88,0	115,0	140,0

Design resistance: concrete C 20/25 – $f_{ck,cube} = 25 \text{ N/mm}^2$, anchor HIT-V 5.8

		ETA-04/0027, issue 2013-06-26 for diamond drilling							
Anchor size		M8	M10	M12	M16	M20	M24	M27	M30
Tensile N_{R_d}	HIT-V 5.8 [kN]	12,0	19,3	28,0	33,6	53,3	73,2	87,3	103,0
Shear V_{R_d}	HIT-V 5.8 [kN]	7,2	12,0	16,8	31,2	48,8	70,4	92,0	112,0

Recommended loads ^{a)}: concrete C 20/25 – $f_{ck,cube} = 25 \text{ N/mm}^2$, anchor HIT-V 5.8

		ETA-04/0027, issue 2013-06-26 for diamond drilling							
Anchor size		M8	M10	M12	M16	M20	M24	M27	M30
Tensile N_{rec}	HIT-V 5.8 [kN]	8,6	13,8	20,0	24,0	38,1	52,3	62,3	73,6
Shear V_{rec}	HIT-V 5.8 [kN]	5,1	8,6	12,0	22,3	34,9	50,3	65,7	80,0

a) With overall partial safety factor for action $\gamma = 1,4$. The partial safety factors for action depend on the type of loading and shall be taken from national regulations.

Service temperature range

Hilti HIT-RE 500 injection mortar may be applied in the temperature ranges given below. An elevated base material temperature may lead to a reduction of the design bond resistance.

Temperature range	Base material temperature	Maximum long term base material temperature	Maximum short term base material temperature
Temperature range I	-40 °C to +40 °C	+24 °C	+40 °C
Temperature range II	-40 °C to +58 °C	+35 °C	+58 °C
Temperature range III	-40 °C to +70 °C	+43 °C	+70 °C

Max short term base material temperature

Short-term elevated base material temperatures are those that occur over brief intervals, e.g. as a result of diurnal cycling.

Max long term base material temperature

Long-term elevated base material temperatures are roughly constant over significant periods of time.

Materials

Mechanical properties of HIT-V / HAS

Anchor size			Data according ETA-04/0027, issue 2013-06-26							Additional Hilti technical data			
			M8	M10	M12	M16	M20	M24	M27	M30	M33	M36	M39
Nominal tensile strength f_{uk}	HIT-V/HAS 5.8 [N/mm ²]		500	500	500	500	500	500	500	500	500	500	500
	HIT-V/HAS 8.8 [N/mm ²]		800	800	800	800	800	800	800	800	800	800	800
	HIT-V/HAS - R [N/mm ²]		700	700	700	700	700	700	500	500	500	500	500
	HIT-V/HAS - HCR [N/mm ²]		800	800	800	800	800	700	700	700	500	500	500
Yield strength f_{yk}	HIT-V/HAS 5.8 [N/mm ²]		400	400	400	400	400	400	400	400	400	400	400
	HIT-V/HAS 8.8 [N/mm ²]		640	640	640	640	640	640	640	640	640	640	640
	HIT-V/HAS - R [N/mm ²]		450	450	450	450	450	450	210	210	210	210	210
	HIT-V/HAS - HCR [N/mm ²]		600	600	600	600	600	400	400	400	250	250	250
Stressed cross-section A_s	HAS [mm ²]		32,8	52,3	76,2	144	225	324	427	519	647	759	913
	HIT-V [mm ²]		36,6	58,0	84,3	157	245	353	459	561	694	817	976
Moment of resistance W	HAS [mm ³]		27,0	54,1	93,8	244	474	809	1274	1706	2321	2949	3891
	HIT-V [mm ³]		31,2	62,3	109	277	541	935	1387	1874	2579	3294	4301

Material quality

Part	Material
Threaded rod HIT-V(F), HAS 5.8 M8 – M24	Strength class 5.8, A ₅ > 8% ductile steel galvanized ≥ 5 μm, (F) hot dipped galvanized ≥ 45 μm,
Threaded rod HIT-V(F), HAS 8.8 M27 – M39	Strength class 8.8, A ₅ > 8% ductile steel galvanized ≥ 5 μm, (F) hot dipped galvanized ≥ 45 μm,
Threaded rod HIT-V-R, HAS-R	Stainless steel grade A4, A ₅ > 8% ductile strength class 70 for ≤ M24 and class 50 for M27 to M30, 1.4401; 1.4404; 1.4578; 1.4571; 1.4439; 1.4362
Threaded rod HIT-V-HCR, HAS-HCR	High corrosion resistant steel, 1.4529; 1.4565 strength ≤ M20: R _m = 800 N/mm ² , R _{p0.2} = 640 N/mm ² , A ₅ > 8% ductile M24 to M30: R _m = 700 N/mm ² , R _{p0.2} = 400 N/mm ² , A ₅ > 8% ductile
Washer ISO 7089	Steel galvanized, hot dipped galvanized
	Stainless steel, 1.4401; 1.4404; 1.4578; 1.4571; 1.4439; 1.4362
	High corrosion resistant steel, 1.4529; 1.4565
Nut EN ISO 4032	Strength class 8, steel galvanized ≥ 5 μm, hot dipped galvanized ≥ 45 μm,
	Strength class 70, stainless steel grade A4, 1.4401; 1.4404; 1.4578; 1.4571; 1.4439; 1.4362
	Strength class 70, high corrosion resistant steel, 1.4529; 1.4565

Anchor dimensions

Anchor size	M8	M10	M12	M16	M20	M24	M27	M30	M33	M36	M39
Anchor rod HAS, HAS-E, HAS-R, HAS-ER HAS-HCR	M8x80	M10x90	M12x110	M16x125	M20x170	M24x210	M27x240	M30x270	M33x300	M36x330	M39x360
Anchor embedment depth [mm]	80	90	110	125	170	210	240	270	300	330	360
Anchor rod HIT-V, HIT-V-R, HIT-V-HCR	Anchor rods HIT-V (-R / -HCR) are available in variable length										



Setting

installation equipment

Anchor size	M8	M10	M12	M16	M20	M24	M27	M30
Rotary hammer	TE2 – TE16				TE40 – TE70			
Other tools	compressed air gun or blow out pump, set of cleaning brushes, dispenser							
Additional Hilti recommended tools	DD EC-1, DD 100 ... DD xxx ^{a)}							

a) For anchors in diamond drilled holes load values for combined pull-out and concrete cone resistance have to be reduced (see section "Setting instruction")

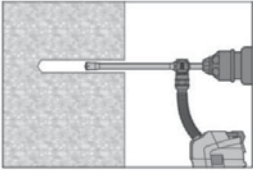
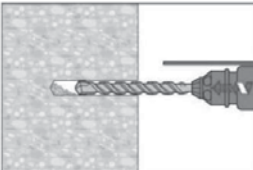
Setting instruction

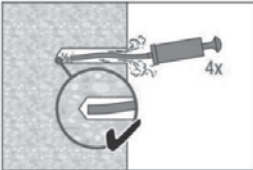
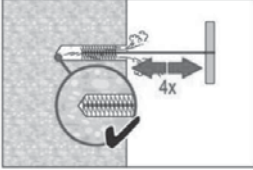
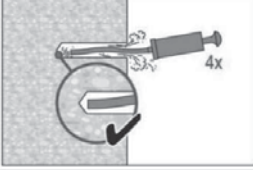
Bore hole drilling	
a) Hilti hollow drill bit	(for dry and wet concrete only)
	Drill hole to the required embedment depth with an appropriately sized Hilti TE-CD or TE-YD hollow drill bit with Hilti vacuum attachment. This drilling system removes the dust and cleans the bore hole during drilling when used in accordance with the user's manual. After drilling is complete, proceed to the "injection preparation" step in the instructions for use.
b) Hammer drilling	(dry or wet concrete and installation in flooded holes (no sea water))
	Drill Hole to the required embedment depth with a hammer drill set in rotation-hammer mode using an appropriately sized carbide drill bit.
c) Diamond coring	(for dry and wet concrete only)
	Diamond coring is permissible when diamond core drilling machine and the corresponding core bit are used.
Bore hole cleaning Just before setting an anchor, the bore hole must be free of dust and debris.	
a) Manual Cleaning (MC) non-cracked concrete only for bore hole diameters $d_0 \leq 20\text{mm}$ and bore hole depth $h_0 \leq 20d$ or $h_0 \leq 250\text{ mm}$ ($d = \text{diameter of element}$)	
	The Hilti manual pump may be used for blowing out bore holes up to diameters $d_0 \leq 20\text{ mm}$ and embedment depths up to $h_{ef} \leq 10d$. Blow out at least 4 times from the back of the bore hole until return air stream is free of noticeable dust
	Brush 4 times with the specified brush size (brush diameter \geq bore hole) by inserting the steel brush Hilti HIT-RB to the back of the hole (if needed with extension) in a twisting motion and removing it. The brush must produce natural resistance as it enters the bore hole - if not the brush is too small and must be replaced with the proper brush diameter.
	Blow out again with manual pump at least 4 times until return air stream is free of noticeable dust.

b) Compressed air cleaning (CAC)

for all bore hole diameters d_0 and all bore hole depth h_0

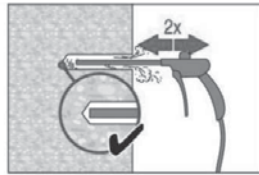

Blow 2 times from the back of the hole (if needed with nozzle extension) over the hole length with oil-free compressed air (min. 6 bar at 6 m³/h) until return air stream is free of noticeable dust.

Bore hole diameter ≥ 32 mm the compressor must supply a minimum air flow of 140 m³/hour.

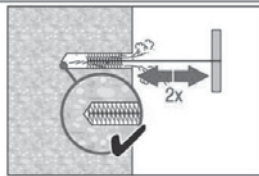

Brush 2 times with the specified brush size by inserting the steel brush Hilti HIT-RB to the back of the hole (if needed with extension) in a twisting motion and removing it.

The brush must produce natural resistance as it enters the bore hole - if not the brush is too small and must be replaced with the proper brush diameter.

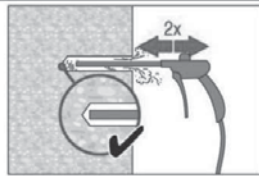

Blow again with compressed air 2 times until return air stream is free of noticeable dust.

c) Cleaning for under water

for all bore hole diameters d_0 and all bore hole depth h_0

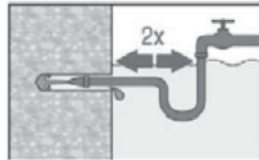

Flush 2 times the hole by inserting a water hose (water-line pressure) to the back of the hole until water runs clear.

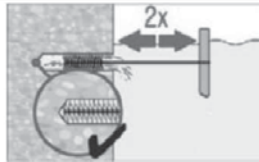

Brush 2 times with the specified brush size by inserting the steel brush Hilti HIT-RB to the back of the hole (if needed with extension) in a twisting motion and removing it.

The brush must produce natural resistance as it enters the bore hole - if not the brush is too small and must be replaced with the proper brush diameter.

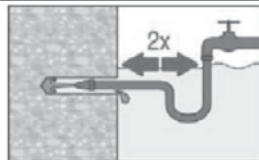

Flush again 2 times the hole by inserting a water hose (water-line pressure) to the back of the hole until water runs clear.

d) Cleaning of hammer drilled holes and diamond cored holes

for all bore hole diameters d_0 and all bore hole depth h_0

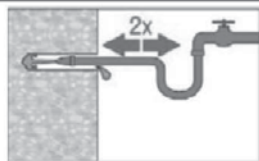

Flush 2 times the hole by inserting a water hose (water-line pressure) to the back of the hole until water runs clear.

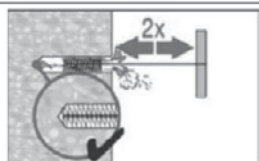

Brush 2 times with the specified brush size by inserting the steel brush Hilti HIT-RB to the back of the hole (if needed with extension) in a twisting motion and removing it.

The brush must produce natural resistance as it enters the bore hole - if not the brush is too small and must be replaced with the proper brush diameter.

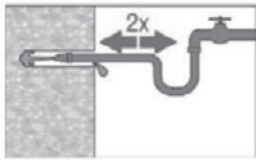

Flush again 2 times the hole by inserting a water hose (water-line pressure) to the back of the hole until water runs clear.

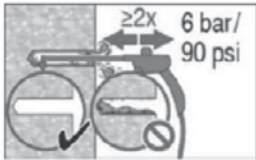

Blow 2 times from the back of the hole (if needed with nozzle extension) over the hole length with oil-free compressed air (min. 6 bar at 6 m³/h) until return air stream is free of noticeable dust and water.

Bore hole diameter ≥ 32 mm the compressor must supply a minimum air flow of 140 m³/hour.

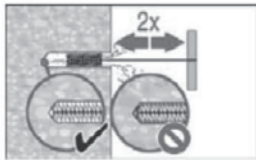

Brush 2 times with the specified brush size by inserting the steel brush Hilti HIT-RB to the back of the hole (if needed with extension) in a twisting motion and removing it.

The brush must produce natural resistance as it enters the bore hole - if not the brush is too small and must be replaced with the proper brush diameter.

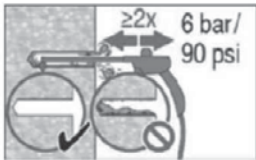

Blow again with compressed air 2 times until return air stream is free of noticeable dust and water.

Injection preparation

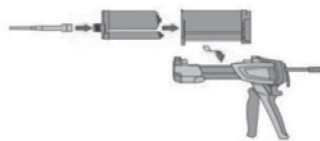

Tightly attach new Hilti mixing nozzle HIT-RE-M to foil pack manifold (snug fit). Do not modify the mixing nozzle. Observe the instruction for use of the dispenser and mortar.

Check foil pack holder for proper function. Do not use damaged foil packs / holders.



Insert foil pack into foil pack holder and put holder into HIT-dispenser.



The foil pack opens automatically as dispensing is initiated. Discard initial adhesive. Depending on the size of the foil pack an initial amount of adhesive has to be discarded.

Discard quantities are:

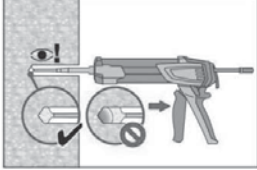
- 2 strokes for 330 ml foil pack,
- 3 strokes for 500 ml foil pack,
- 65 ml for 1400 ml foil pack.

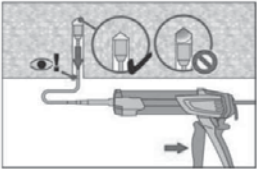
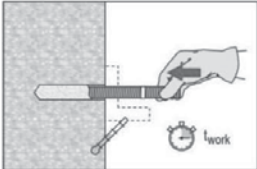
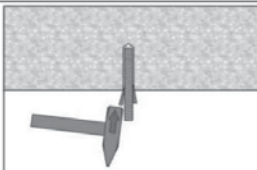
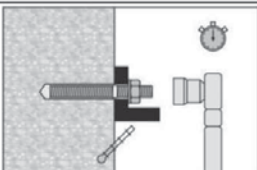
Inject adhesive from the back of the borehole without forming air voids	
	<p>Inject the adhesive starting at the back of the hole, slowly withdrawing the mixer with each trigger pull.</p> <p>Fill holes approximately 2/3 full. It is required that the annular gap between the anchor and the concrete is completely filled with adhesive along the embedment length.</p>
	<p>After injection is completed, depressurize the dispenser by pressing the release trigger. This will prevent further adhesive discharge from the mixer.</p>
	<p>Overhead installation and/or installation with embedment depth $h_{ef} > 250\text{mm}$.</p> <p>For overhead installation the injection is only possible with the aid of extensions and piston plugs. Assemble HIT-RE-M mixer, extension(s) and appropriately sized piston plug HIT-SZ. Insert piston plug to back of the hole and inject adhesive. During injection the piston plug will be naturally extruded out of the bore hole by the adhesive pressure.</p> <p>Under water application: fill borehole completely with mortar.</p>
Setting the element	
	<p>Before use, verify that the element is dry and free of oil and other contaminants.</p> <p>Mark and set element to the required embedment depth until working time t_{work} has elapsed.</p>
	<p>For overhead installation use piston plugs and fix embedded parts with e.g. wedges HIT-OHW.</p>
	<p>Loading the anchor:</p> <p>After required curing time t_{cure} the anchor can be loaded.</p> <p>The applied installation torque shall not exceed T_{max}.</p>

For detailed information on installation see instruction for use given with the package of the product.

Curing time for general conditions

Data according ETA-04/0027, issue 2013-06-26		
Temperature of the base material	Working time in which anchor can be inserted and adjusted t_{gel}	Curing time before anchor can be fully loaded t_{cure}
40 °C	12 min	4 h
30 °C to 39 °C	12 min	8 h
20 °C to 29 °C	20 min	12 h
15 °C to 19 °C	30 min	24 h
10 °C to 14 °C	90 min	48 h
5 °C to 9 °C	120 min	72 h

For dry concrete curing times may be reduced according to the following table.
For installation temperatures below +5 °C all load values have to be reduced according to the load reduction factors given below.

Curing time for dry concrete

Additional Hilti technical data			
Temperature of the base material	Working time in which anchor can be inserted and adjusted t_{gel}	Reduced curing time before anchor can be fully loaded $t_{cure,dry}$	Load reduction factor
40 °C	12 min	4 h	1
30 °C	12 min	8 h	1
20 °C	20 min	12 h	1
15 °C	30 min	18 h	1
10 °C	90 min	24 h	1
5 °C	120 min	36 h	1
0 °C	3 h	50 h	0,7
-5 °C	4 h	72 h	0,6

Setting details

			Data according ETA-04/0027, issue 2013-06-26							Additional Hilti technical data			
Anchor size			M8	M10	M12	M16	M20	M24	M27	M30	M33	M36	M39
Nominal diameter of drill bit	d_0	[mm]	10	12	14	18	24	28	30	35	37	40	42
Effective anchorage and drill hole depth range ^{a)}	$h_{ef,min}$	[mm]	40	40	48	64	80	96	108	120	132	144	156
	$h_{ef,max}$	[mm]	160	200	240	320	400	480	540	600	660	720	780
Minimum base material thickness	h_{min}	[mm]	$h_{ef} + 30 \text{ mm}$ $\geq 100 \text{ mm}$				$h_{ef} + 2 d_0$						
Diameter of clearance hole in the fixture	d_f	[mm]	9	12	14	18	22	26	30	33	36	39	42
Minimum spacing	s_{min}	[mm]	40	50	60	80	100	120	135	150	165	180	195
Minimum edge distance	c_{min}	[mm]	40	50	60	80	100	120	135	150	165	180	195
Critical spacing for splitting failure	$s_{cr,sp}$		$2 c_{cr,sp}$										
Critical edge distance for splitting failure ^{b)}	$c_{cr,sp}$	[mm]	$1,0 \cdot h_{ef}$ for $h / h_{ef} \geq 2,0$										
			$4,6 h_{ef} - 1,8 h$ for $2,0 > h / h_{ef} > 1,3$										
			$2,26 h_{ef}$ for $h / h_{ef} \leq 1,3$										
Critical spacing for concrete cone failure	$s_{cr,N}$		$2 c_{cr,N}$										
Critical edge distance for concrete cone failure ^{c)}	$c_{cr,N}$		$1,5 h_{ef}$										
Torque moment ^{d)}	T_{max}	[Nm]	10	20	40	80	150	200	270	300	330	360	390

For spacing (edge distance) smaller than critical spacing (critical edge distance) the design loads have to be reduced.

- a) $h_{ef,min} \leq h_{ef} \leq h_{ef,max}$ (h_{ef} : embedment depth)
- b) h : base material thickness ($h \geq h_{min}$)
- c) The critical edge distance for concrete cone failure depends on the embedment depth h_{ef} and the design bond resistance. The simplified formula given in this table is on the safe side.
- d) This is the maximum recommended torque moment to avoid splitting failure during installation for anchors with minimum spacing and/or edge distance.

Simplified design method

Simplified version of the design method according ETAG 001, TR 029. Design resistance according data given in ETA-04/0027, issue 2009-05-20.

- Influence of concrete strength
- Influence of edge distance
- Influence of spacing
- Valid for a group of two anchors. (The method may also be applied for anchor groups with more than two anchors or more than one edge distance. The influencing factors must then be considered for each edge distance and spacing. The calculated design loads are then on the same side: They will be lower than the exact values according ETAG 001, TR 029. To avoid this, it is recommended to use the anchor design software PROFIS anchor)

The design method is based on the following simplification:

- No different loads are acting on individual anchors (no eccentricity)

The values are valid for one anchor.

For more complex fastening applications please use the anchor design software PROFIS Anchor.

Tension loading

The design tensile resistance is the lower value of

- Steel resistance: $N_{Rd,s}$
- Combined pull-out and concrete cone resistance:
 $N_{Rd,p} = N_{Rd,p}^0 \cdot f_{B,p} \cdot f_{1,N} \cdot f_{2,N} \cdot f_{3,N} \cdot f_{h,p} \cdot f_{re,N}$
- Concrete cone resistance: $N_{Rd,c} = N_{Rd,c}^0 \cdot f_B \cdot f_{1,N} \cdot f_{2,N} \cdot f_{3,N} \cdot f_{h,N} \cdot f_{re,N}$
- Concrete splitting resistance (only non-cracked concrete):
 $N_{Rd,sp} = N_{Rd,c}^0 \cdot f_B \cdot f_{1,sp} \cdot f_{2,sp} \cdot f_{3,sp} \cdot f_{h,N} \cdot f_{re,N}$

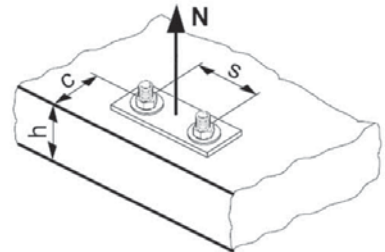

Basic design tensile resistance

Design steel resistance $N_{Rd,s}$

		Data according ETA-04/0027, issue 2013-06-26								Additional Hilti technical data		
Anchor size		M8	M10	M12	M16	M20	M24	M27	M30	M33	M36	M39
$N_{Rd,s}$	HAS 5.8 [kN]	11,3	17,3	25,3	48,0	74,7	106,7	-	-	-	-	-
	HIT-V 5.8 [kN]	12,0	19,3	28,0	52,7	82,0	118,0	153,3	187,3	231,3	272,3	325,3
	HAS 8.8 [kN]	-	-	-	-	-	-	231,3	281,3	345,1	404,8	486,9
	HIT-V 8.8 [kN]	19,3	30,7	44,7	84,0	130,7	188,0	244,7	299,3	370,1	435,7	520,5
	HAS (-E)-R [kN]	12,3	19,8	28,3	54,0	84,0	119,8	75,9	92,0	113,2	132,8	159,8
	HIT-V-R [kN]	13,9	21,9	31,6	58,8	92,0	132,1	80,4	98,3	122,6	144,3	172,4
	HAS (-E)-HCR [kN]	18,0	28,0	40,7	76,7	120,0	106,7	144,8	175,7	134,8	158,1	190,2
	HIT-V-HCR [kN]	19,3	30,7	44,7	84,0	130,7	117,6	152,9	187,1	144,6	170,2	203,3

Design combined pull-out and concrete cone resistance for anchors ^{a)}

$$N_{Rd,p} = N_{Rd,p}^0 \cdot f_{B,p} \cdot f_{1,N} \cdot f_{2,N} \cdot f_{3,N} \cdot f_{h,p} \cdot f_{re,N}$$

			Data according ETA-04/0027, issue 2013-06-26							Additional Hilti technical data			
Anchor size			M8	M10	M12	M16	M20	M24	M27	M30	M33	M36	M39
Typical embedment depth $h_{ef,typ}$ [mm]			80	90	110	125	170	210	240	270	300	330	360
Hammer drilling + Hilti hollow drill bit	$N_{Rd,p}^0$ [kN]	Temp range I	15.3	21.5	31.6	44.9	76.3	105.6	135.7	157.5	171,0	203,3	232,9
	$N_{Rd,p}^0$ [kN]	Temp range II	12.4	17.5	25.7	35.9	61.0	82.9	106.6	133.3	136,8	162,6	186,3
	$N_{Rd,p}^0$ [kN]	Temp range III	7.7	10.8	15.8	22.4	35.6	52.8	63.0	78.8	82,1	97,6	111,8
Diamond coring	$N_{Rd,p}^0$ [kN]	Temp range I	14.5	20.4	29.9	35.9	56.0	75.4	87.2	103.0	-	-	-
	$N_{Rd,p}^0$ [kN]	Temp range II	12.3	17.3	25.3	28.4	45.8	60.3	67.9	78.8	-	-	-
	$N_{Rd,p}^0$ [kN]	Temp range III	7.3	10.2	15.0	16.5	25.4	33.9	43.6	48.5	-	-	-

a) Additional Hilti technical data (not part of ETA-04/0027, issue 2013-06-26):

The design values for combined pull-out and concrete cone resistance may be increased by 20 % for anchor installation in dry concrete (concrete not in contact with water before/during installation and curing).

Design concrete cone resistance ^{a)} $N_{Rd,c} = N_{Rd,c}^0 \cdot f_B \cdot f_{1,N} \cdot f_{2,N} \cdot f_{3,N} \cdot f_{h,N} \cdot f_{re,N}$

Design splitting resistance $N_{Rd,sp}$ ^{a)} $= N_{Rd,c}^0 \cdot f_B \cdot f_{1,sp} \cdot f_{2,sp} \cdot f_{3,sp} \cdot f_{h,N} \cdot f_{re,N}$

			Data according ETA-04/0027, issue 2013-06-26							Additional Hilti technical data			
Anchor size			M8	M10	M12	M16	M20	M24	M27	M30	M33	M36	M39
$N_{Rd,c}^0$	[kN]		17,2	20,5	27,7	33,6	53,3	73,2	89,4	106,7	125,0	144,2	164,3

a) Additional Hilti technical data (not part of ETA-04/0027, issue -2013-06-26):

The design values for concrete cone and splitting resistance may be increased by 20 % for anchor installation in dry concrete (concrete not in contact with water before/during installation and curing).

Influencing factors

Influence of concrete strength on combined pull-out and concrete cone resistance

Concrete strength designation (ENV 206)	C 20/25	C 25/30	C 30/37	C 35/45	C 40/50	C 45/55	C 50/60
$f_{B,p} = (f_{ck,cube}/25N/mm^2)^{0.1}$ ^{a)}	1	1,02	1,04	1,06	1,07	1,08	1,09

a) $f_{ck,cube}$ = concrete compressive strength, measured on cubes with 150 mm side length

Influence of embedment depth on combined pull-out and concrete cone resistance

$$f_{h,p} = h_{ef}/h_{ef,typ}$$

Influence of concrete strength on concrete cone resistance

Concrete strength designation (ENV 206)	C 20/25	C 25/30	C 30/37	C 35/45	C 40/50	C 45/55	C 50/60
$f_B = (f_{ck,cube}/25N/mm^2)^{1/2}$ ^{a)}	1	1,1	1,22	1,34	1,41	1,48	1,55

a) $f_{ck,cube}$ = concrete compressive strength, measured on cubes with 150 mm side length

Influence of edge distance ^{a)}

$c/c_{cr,N}$	0,1	0,2	0,3	0,4	0,5	0,6	0,7	0,8	0,9	1
$c/c_{cr,sp}$										
$f_{1,N} = 0,7 + 0,3 \cdot c/c_{cr,N}$	0,73	0,76	0,79	0,82	0,85	0,88	0,91	0,94	0,97	1
$f_{1,sp} = 0,7 + 0,3 \cdot c/c_{cr,sp}$										
$f_{2,N} = 0,5 \cdot (1 + c/c_{cr,N})$	0,55	0,60	0,65	0,70	0,75	0,80	0,85	0,90	0,95	1
$f_{2,sp} = 0,5 \cdot (1 + c/c_{cr,sp})$										

a) The edge distance shall not be smaller than the minimum edge distance c_{min} given in the table with the setting details. These influencing factors must be considered for every edge distance smaller than the critical edge distance.

Influence of anchor spacing ^{a)}

$s/s_{cr,N}$	0,1	0,2	0,3	0,4	0,5	0,6	0,7	0,8	0,9	1
$s/s_{cr,sp}$										
$f_{3,N} = 0,5 \cdot (1 + s/s_{cr,N})$	0,55	0,60	0,65	0,70	0,75	0,80	0,85	0,90	0,95	1
$f_{3,sp} = 0,5 \cdot (1 + s/s_{cr,sp})$										

a) The anchor spacing shall not be smaller than the minimum anchor spacing s_{min} given in the table with the setting details. This influencing factor must be considered for every anchor spacing.

Influence of embedment depth on concrete cone resistance

$$f_{h,N} = (h_{ef}/h_{ef,typ})^{1,5}$$

Influence of reinforcement

h_{ef} [mm]	40	50	60	70	80	90	≥ 100
$f_{re,N} = 0,5 + h_{ef}/200mm \leq 1$	0,7 ^{a)}	0,75 ^{a)}	0,8 ^{a)}	0,85 ^{a)}	0,9 ^{a)}	0,95 ^{a)}	1

a) This factor applies only for dense reinforcement. If in the area of anchorage there is reinforcement with a spacing ≥ 150 mm (any diameter) or with a diameter ≤ 10 mm and a spacing ≥ 100 mm, then a factor $f_{re} = 1$ may be applied.

Shear loading

The design shear resistance is the lower value of

- Steel resistance: $V_{Rd,s}$
- Concrete pryout resistance: $V_{Rd,cp} = k \cdot \text{lower value of } N_{Rd,p} \text{ and } N_{Rd,c}$
- Concrete edge resistance: $V_{Rd,c} = V_{Rd,c}^0 \cdot f_B \cdot f_h \cdot f_4 \cdot f_{hef} \cdot f_c$

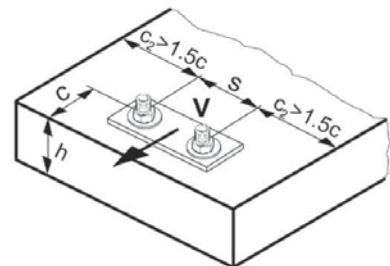

Basic design shear resistance

Design steel resistance $V_{Rd,s}$

		Data according ETA-04/0027, issue 2013-06-26								Additional Hilti technical data		
Anchor size		M8	M10	M12	M16	M20	M24	M27	M30	M33	M36	M39
$V_{Rd,s}$	HAS 5.8 [kN]	6,8	10,4	15,2	28,8	44,8	64,0	-	-	-	-	-
	HIT-V 5.8 [kN]	7,2	12,0	16,8	31,2	48,8	70,4	92,0	112,0	138,8	163,4	195,2
	HAS 8.8 [kN]	-	-	-	-	-	-	139,2	168,8	207,0	242,9	292,2
	HIT-V 8.8 [kN]	12,0	18,4	27,2	50,4	78,4	112,8	147,2	179,2	222,1	261,4	312,3
	HAS (-E)-R [kN]	7,7	12,2	17,3	32,7	50,6	71,8	45,8	55,5	67,9	79,7	95,9
	HIT-V-R [kN]	8,3	12,8	19,2	35,3	55,1	79,5	48,3	58,8	72,9	85,8	102,5
	HAS (-E)-HCR [kN]	10,4	16,8	24,8	46,4	72,0	64,0	86,9	105,7	80,9	94,9	114,1
	HIT-V-HCR [kN]	12,0	18,4	27,2	50,4	78,4	70,9	92,0	112,0	86,8	102,1	122,0

Design concrete pryout resistance $V_{Rd,cp}$ = lower value^{a)} of $k \cdot N_{Rd,p}$ and $k \cdot N_{Rd,c}$

$$k = 1 \text{ for } h_{ef} < 60 \text{ mm}$$

$$k = 2 \text{ for } h_{ef} \geq 60 \text{ mm}$$

- a) $N_{Rd,p}$: Design combined pull-out and concrete cone resistance
 $N_{Rd,c}$: Design concrete cone resistance

Design concrete edge resistance $V_{Rd,c} = V_{Rd,c}^0 \cdot f_B \cdot f_\beta \cdot f_h \cdot f_4 \cdot f_{hef} \cdot f_c$

Anchor size	M8	M10	M12	M16	M20	M24	M27	M30	M33	M36	M39
Non-cracked concrete											
$V_{Rd,c}^0$ [kN]	5,9	8,6	11,6	18,7	27,0	36,6	44,5	53,0	62,1	71,7	81,9

Influencing factors

Influence of concrete strength

Concrete strength designation (ENV 206)	C 20/25	C 25/30	C 30/37	C 35/45	C 40/50	C 45/55	C 50/60
$f_B = (f_{ck,cube}/25\text{N/mm}^2)^{1/2}$ a)	1	1,1	1,22	1,34	1,41	1,48	1,55

- a) $f_{ck,cube}$ = concrete compressive strength, measured on cubes with 150 mm side length

Influence of angle between load applied and the direction perpendicular to the free edge

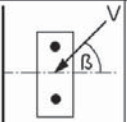
Angle β	0°	10°	20°	30°	40°	50°	60°	70°	80°	≥ 90°
$f_\beta = \sqrt{\frac{1}{(\cos \alpha_r)^2 + \left(\frac{\sin \alpha_r}{2,5}\right)^2}}$ 	1	1,01	1,05	1,13	1,24	1,40	1,64	1,97	2,32	2,50

Influence of base material thickness

h/c	0,15	0,3	0,45	0,6	0,75	0,9	1,05	1,2	1,35	≥ 1,5
$f_h = \{h/(1,5 \cdot c)\}^{1/2} \leq 1$	0,32	0,45	0,55	0,63	0,71	0,77	0,84	0,89	0,95	1,00

Influence of anchor spacing and edge distance ^{a)} for concrete edge resistance: f_4
 $f_4 = (c/h_{ef})^{1,5} \cdot (1 + s / [3 \cdot c]) \cdot 0,5$

c/h _{ef}	Single anchor	Group of two anchors s/h _{ef}														
		0,75	1,50	2,25	3,00	3,75	4,50	5,25	6,00	6,75	7,50	8,25	9,00	9,75	10,50	11,25
0,50	0,35	0,27	0,35	0,35	0,35	0,35	0,35	0,35	0,35	0,35	0,35	0,35	0,35	0,35	0,35	0,35
0,75	0,65	0,43	0,54	0,65	0,65	0,65	0,65	0,65	0,65	0,65	0,65	0,65	0,65	0,65	0,65	0,65
1,00	1,00	0,63	0,75	0,88	1,00	1,00	1,00	1,00	1,00	1,00	1,00	1,00	1,00	1,00	1,00	1,00
1,25	1,40	0,84	0,98	1,12	1,26	1,40	1,40	1,40	1,40	1,40	1,40	1,40	1,40	1,40	1,40	1,40
1,50	1,84	1,07	1,22	1,38	1,53	1,68	1,84	1,84	1,84	1,84	1,84	1,84	1,84	1,84	1,84	1,84
1,75	2,32	1,32	1,49	1,65	1,82	1,98	2,15	2,32	2,32	2,32	2,32	2,32	2,32	2,32	2,32	2,32
2,00	2,83	1,59	1,77	1,94	2,12	2,30	2,47	2,65	2,83	2,83	2,83	2,83	2,83	2,83	2,83	2,83
2,25	3,38	1,88	2,06	2,25	2,44	2,63	2,81	3,00	3,19	3,38	3,38	3,38	3,38	3,38	3,38	3,38
2,50	3,95	2,17	2,37	2,57	2,77	2,96	3,16	3,36	3,56	3,76	3,95	3,95	3,95	3,95	3,95	3,95
2,75	4,56	2,49	2,69	2,90	3,11	3,32	3,52	3,73	3,94	4,15	4,35	4,56	4,56	4,56	4,56	4,56
3,00	5,20	2,81	3,03	3,25	3,46	3,68	3,90	4,11	4,33	4,55	4,76	4,98	5,20	5,20	5,20	5,20
3,25	5,86	3,15	3,38	3,61	3,83	4,06	4,28	4,51	4,73	4,96	5,18	5,41	5,63	5,86	5,86	5,86
3,50	6,55	3,51	3,74	3,98	4,21	4,44	4,68	4,91	5,14	5,38	5,61	5,85	6,08	6,31	6,55	6,55
3,75	7,26	3,87	4,12	4,36	4,60	4,84	5,08	5,33	5,57	5,81	6,05	6,29	6,54	6,78	7,02	7,26
4,00	8,00	4,25	4,50	4,75	5,00	5,25	5,50	5,75	6,00	6,25	6,50	6,75	7,00	7,25	7,50	7,75
4,25	8,76	4,64	4,90	5,15	5,41	5,67	5,93	6,18	6,44	6,70	6,96	7,22	7,47	7,73	7,99	8,25
4,50	9,55	5,04	5,30	5,57	5,83	6,10	6,36	6,63	6,89	7,16	7,42	7,69	7,95	8,22	8,49	8,75
4,75	10,35	5,45	5,72	5,99	6,27	6,54	6,81	7,08	7,36	7,63	7,90	8,17	8,45	8,72	8,99	9,26
5,00	11,18	5,87	6,15	6,43	6,71	6,99	7,27	7,55	7,83	8,11	8,39	8,66	8,94	9,22	9,50	9,78
5,25	12,03	6,30	6,59	6,87	7,16	7,45	7,73	8,02	8,31	8,59	8,88	9,17	9,45	9,74	10,02	10,31
5,50	12,90	6,74	7,04	7,33	7,62	7,92	8,21	8,50	8,79	9,09	9,38	9,67	9,97	10,26	10,55	10,85

a) The anchor spacing and the edge distance shall not be smaller than the minimum anchor spacing s_{min} and the minimum edge distance c_{min} .

Influence of embedment depth

h_{ef}/d	4	4,5	5	6	7	8	9	10	11
$f_{hef} = 0,05 \cdot (h_{ef} / d)^{1,68}$	0,51	0,63	0,75	1,01	1,31	1,64	2,00	2,39	2,81
h_{ef}/d	12	13	14	15	16	17	18	19	20
$f_{hef} = 0,05 \cdot (h_{ef} / d)^{1,68}$	3,25	3,72	4,21	4,73	5,27	5,84	6,42	7,04	7,67

Influence of edge distance ^{a)}

c/d	4	6	8	10	15	20	30	40
$f_c = (d / c)^{0,19}$	0,77	0,71	0,67	0,65	0,60	0,57	0,52	0,50

a) The edge distance shall not be smaller than the minimum edge distance c_{min} .

Combined tension and shear loading for hammer drilling or hollow drill bit

For combined tension and shear loading see section "Anchor Design".